

MEASUREMENT OF BASIC STATIC CHARACTERISTICS (I-V, C-V) OF SILICON DETECTORS

A.I. Sheremetyeva¹, E.A. Streletskaia¹

¹ *Joint Institute for Nuclear Research, 6 Joliot-Curie St, Dubna, Moscow region, 141980, Russia*

E-mail: anashafronovskaya@mail.ru, estreletskaya@bk.ru

The use of microstrip detectors in developing coordinate track systems for HEP experiments with high geometric efficiency (~100%), a large number of strips (measuring channels) over 10^6 and accuracy $a/\sqrt{12}$ (a-pitch) requires careful preliminary selection of detectors by main parameters. The main static parameters of silicon microstrip detectors are as follows: I-V characteristic determines the amount of dark leakage current of a silicon detector. C-V characteristic allows defining the full depletion voltage and the value of the capacitance of both the strip and detector.

Keywords: Double sided Si-microstrip detector, CBM

Anastasia Sheremetyeva, Ekaterina Streletskaia

Copyright © 2019 for this paper by its authors.
Use permitted under Creative Commons License Attribution 4.0 International (CC BY 4.0).

1. The need to measure basic static parameters of silicon detectors

The use of double sided microstrip silicon detectors (DSSD) to establish precision coordinate planes for internal trackers of the BM@N, MPD, SPD, experiments for the NICA complex (JINR) and for the CBM experiment (GSI) requires careful preliminary selection of the detectors for the main parameters.

The current-voltage characteristic (I-V) determines the value of the dark leakage current DSSD, which integrally characterizes the quality and determines the possibility of using this detector in further process of developing a coordinate plane.

The capacitance-voltage characteristic (C-V) makes it possible to determine the full depletion voltage U_{fd} and the capacitance of the strip and the entire detector.

AC-coupling DSSD (Hamamatsu) were measured for the CBM experiment with a size of $62 \times 22 \text{ mm}^2$ (Fig.1). The total number of strips is 1024, the chip thickness $300 \text{ }\mu\text{m}$, the strip pitch $58 \text{ }\mu\text{m}$, the strip implant width $10 \text{ }\mu\text{m}$, the strip metal width $20 \text{ }\mu\text{m}$, the strip angle of P side is $7,5^\circ$, the strip angle of N side is 0° [1].

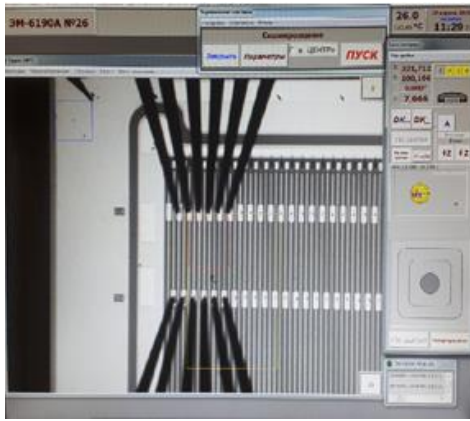

Figure 1. Fragment of alignment of the contact pads of the sensor with probes

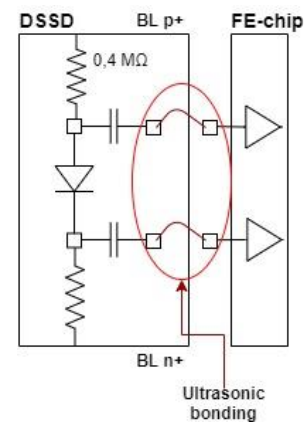

Figure 2. Electrical equivalent circuit of AC-coupling DSSD

For detectors with AC-coupling topology, an important parameter is the value of the leakage currents of integration capacitors ($I_d \leq 10^{-12} \text{ A}$). Leakage currents flow through the inputs of low-noise charge-sensitive amplifiers of integrated specialized FE-chips (Fig.2). The larger capacitor leakage currents, the higher the noise level in this channel is. It is necessary to identify and enter such strips into the database so that then these channels are not connected to FE-chips or, if there are a large number of such channels, this detector is excluded from the assembly.

2. Instruments for measuring basic static characteristics of microstrips detectors

Modern systems for testing and selecting microstrip detectors allow automatic identification of strips with large dark currents, short circuits, and interstrip metallization breaks [2].

With the joint cooperation of LHEP (JINR), SINP (MSU) and Planar (Minsk), an automated measuring complex was developed for testing this type of the detector (Fig.3), which consists of the following parts:

1. EM-6190 probe automat with a coordinate table, positioning accuracy of $8 \text{ }\mu\text{m}$;
2. Probe card with 12 probes, probe pitch $58 \text{ }\mu\text{m}$;
3. Microscope equipped with an electronic vision device;
4. Programmable switching matrix of signals Keithley 708B;
5. LCR meter AM-3016;
6. Keithley 6487 picoammeter with built-in controlled voltage source in the range $(0,0002 \div 505 \text{ V})$ for both voltage polarities;
7. Picoammeter Keithley 6485;
8. The software package "DMS" for controlling the measuring complex.



Figure 3. Automated measuring complex

The probe automate EM-6190A is designed for an accurate automatic positioning of the measured detector relative to the probe card and for ensuring electrical contact of the measuring probes with contact pads on the detector strips.

The measuring complex is controlled with the help of the DMS software package. The program connects measuring instruments through the switch to measure the required detector parameters and saves the received data in the TXT files.

3. Measurement results

The basic static characteristic of the microstrip detector is the current-voltage characteristic, which is the dependence of the current on the voltage applied to it.

According to the specification requirements for the Hamamatsu detectors with the dimensions of $62 \times 22 \times 0,3 \text{ mm}^3$, the value of the dark current detector should not exceed $0,8 \mu\text{A}$ at a voltage of 150 V and temperature of measurement $+20^\circ\text{C}$. The I-V characteristic of the CBM62HDS0424 sensor (Fig.4) clearly shows the current value at a voltage of 150 is 183,8 nA, which meets the requirements of the specification.

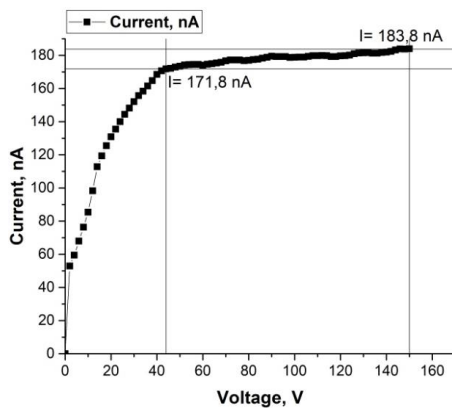

Figure 4. Complete I-V characteristic of a silicon microstrip detector of the type $62 \times 22 \times 0,3 \text{ mm}^3$

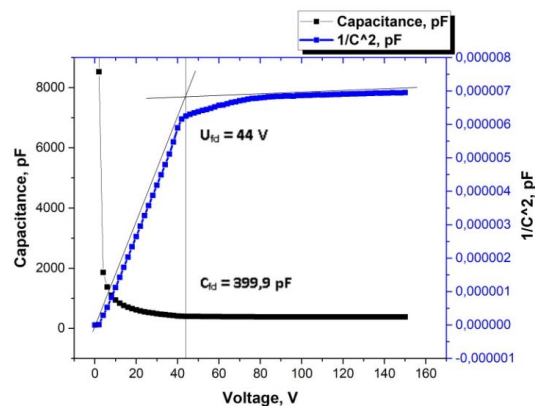

Figure 5. C-V characteristic of a silicon microstrip detector of the type $62 \times 22 \times 0,3 \text{ mm}^3$

Capacitance-voltage characteristic is the dependence of the applied voltage. The C-V characteristic makes it possible to determine the value of full depletion voltage U_{fd} of the detector. Total depletion voltage is the reverse voltage at which the space charge region (SCR) reaches ohmic contact [1].

The size of the SCR for a sharp (p-n) transition depends on the bias voltage and is described by the formula:

$$d(\mu\text{m}) = 18\sqrt{\rho(\text{kOhm}\cdot\text{cm})U_d(\text{V})} \quad (1)$$

Where: d (μm) – thickness of SCR, ρ ($\text{kOhm}\cdot\text{cm}$) – resistivity, U_d (V) – reverse voltage at the detector.

From formula (1), we derive the formula for calculating the reverse voltage at the detector:

$$U_d = \frac{d^2}{324 \times \rho} \quad (2)$$

Figure 5 shows the measured (C-V characteristic) dependence $C = f(U)$, black. The calculated dependence $C^{-2} = f(U)$ is shown in blue, from which the full depletion detector is determined from the position of the intersection point of two straight lines of the graph linear approximation. For this detector, full depletion voltage is $U_{fd} = 44$ V and the geometric capacitance of the detector $C_{fd} = 399,9$ pF corresponds to it.

This detector with such parameters complies with the specifications of the CBM experiment and can enter the assembly process of working coordinate modules. After measuring the general parameters of the detector, in accordance with their specifications, more complex and time-consuming measurements of the leakage currents of the integral separation capacitors of each of the 1024 strips are continued, they are necessary to detect noisy channels. Below are the graphs with the results of data processing for 40 pcs = 40 880 strips (p^+) + 40 880 strips (n^+).

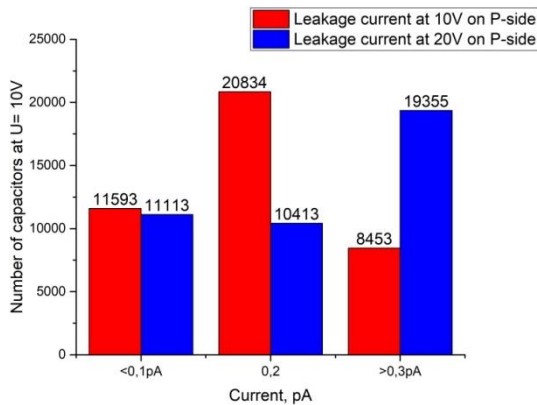

Figure 6. Histograms of capacitors leakage currents on the P-side at 10 and 20 V

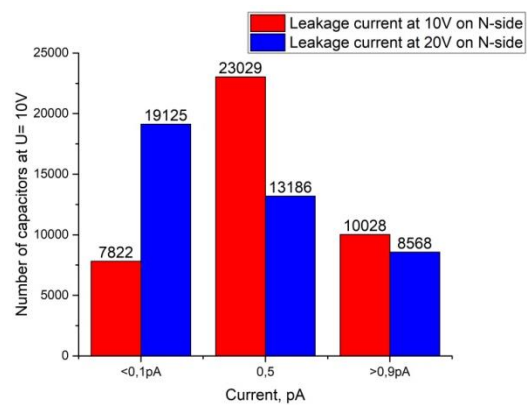

Figure 7. Histograms of capacitors leakage currents on the N-side at 10 and 20 V

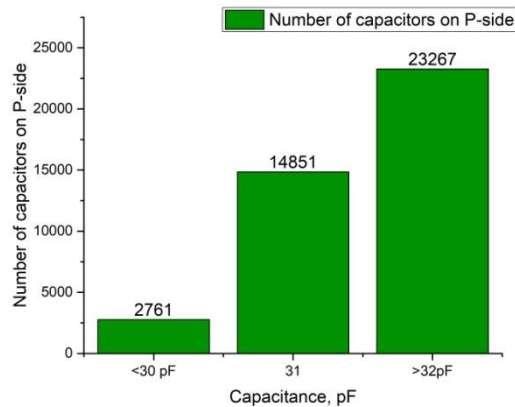

Figure 8. Capacitance values on the P-side

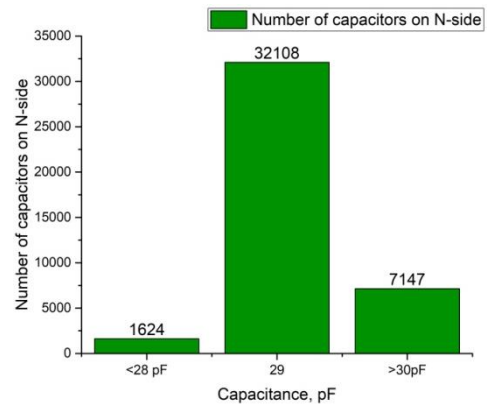

Figure 9. Capacitance values on the N-side

Histograms (Fig. 6) show that on the P-side the strip current at a voltage of 10 and 20 V does not exceed 0,3 pA. Histograms (Fig. 7) show that on the N-side the strip current at a voltage of 10 and 20 V does not exceed 0,9 pA.

From the obtained measurement results of more than 80 thousand integral isolation capacitors, it can be concluded that Hamamatsu detectors with dimensions (62x22x0.3) mm³ have small leakage currents at a voltage of 20 V and will not contribute to noise.

Histogram (Fig. 8) shows that on the P-side, the capacitance of integrated capacitors does not exceed 32 pF. The capacitance value is less than 30 pF, due to the presence of short strips on the P-side of the detector. The total number of short strips is 78 on both sides of P-side.

Histogram (Fig. 9) shows that on the N-side, the capacitance of integrated capacitors does not exceed 30 pF.

As a result of measurements, the following defects were identified:

Table 1. Defect “Coupling short”

Sensor	No Strip	Current (I_c) at 10 V on N-side	Current (I_c) at 20 V on N-side	Capacitance	Defect
CBM62HDS0420	252	145 nA	201 nA	777,4 pF	Coupling short

Table 2. Defect “Strip metallization gap”

Sensor	No Strip	Current (I_c) at 10 V on N-side	Current (I_c) at 20 V on N-side	Capacitance	Defect
CBM62HDS0444	522	0,0001 nA	0,0001 nA	6 pF	Strip metallization gap

Table 3. Defect “Breakdown”

Sensor	Current (I_d) at 80 V	Current (I_d) at 150 V	Defect
CBM62HDS0441	350 nA	8 mA	Breakdown

References

- [1] Technical Design Report for the CBM. Silicon Tracking System (STS). Available at:
<http://repository.gsi.de>
- [2] Golutvin, I. et al. // Hardware-software complex for measuring electrical static parameters of silicon detectors. JINR print P13-2003-203. Dubna, 2003.
- [3] Zamiatin, N. Development and application of planar silicon detectors for experiments with high radiation fluxes: Dis. ... Candidate of Engineering Sciences: 01.04.23. Dubna: JINR, 2001. 14 p.