

# Neuro-fuzzy Control System for a Non-deterministic Object in Real Time

Sergey Ivanov<sup>a</sup>, Nataliia Maksyshko<sup>a</sup> and Mykola Ivanov<sup>a</sup>

<sup>a</sup>Zaporizhzhia National University, Zhukovsky str., 66, Zaporizhzhia, 69063, Ukraine

## Abstract

In this paper discusses the use of neuro-fuzzy control systems as a tool for managing non-deterministic objects in real time. This paper discusses modern control tools structural models of a discrete quasi-invariant automated control system. In this paper the analysis of an automated control system is presented, which is based on the use of typical models of discrete automated control systems. According to the proposed solution in the automated control system in real time it is proposed to use a neuro-fuzzy control system as a function of the object and the system's transfer ratio. The neuro-fuzzy control system is based on the learning process of an artificial neural network (ANN), which allows to define the rules of fuzzy inference (FIS). The paper proposes the ANFIS model, which is implemented by using the fuzzy system Takagi T., Sugeno M., also is considered an algorithm based on seven fuzzy rules. In this paper is presented a technique for implementing a neuro-fuzzy control system for non-deterministic objects by using Matlab. The use of Matlab made possible to create a model of an adaptive neuro-fuzzy inference system. The paper describes the process of training a neural network, where a hybrid method is chosen, which is a combination of the least squares method and the method of decreasing the inverse gradient. The results of testing a neuro-fuzzy control system of a non-deterministic object are presented, which confirmed the possibility of using a neuro-fuzzy control model. It is constructed the structure and the result in the form of a control surface of the neuro-fuzzy ANFIS model. The results presented in this paper allow to conclude about the possibility of using a neuro-fuzzy control system for non-deterministic objects in real time.

## Keywords

Neuro-fuzzy control systems, adaptive neural network (ANN), fuzzy inference system (FIS), ANFIS model

## 1. Introduction

One of the methods for constructing modern control systems is the synthesis of intelligent systems based on neuro-fuzzy systems [1]. The peculiarity of systems of this class is the use of neural networks and fuzzy logic to control complex dynamic objects that function under conditions of uncertainty and conflict. Uncertainty in this case it exists a lack of information, which is necessary to obtain a quantitative description of the processes occurring in the system, and the complexity of the control object. The use of classical methods, the description of the control system assumes that the control objects are described by linear dynamic links of a low order. This assumption often leads to the fact that classical control systems in practice do not provide the desired indicators of fast and efficient control. Therefore, the neuro-fuzzy control system, using the procedures of artificial neural networks and fuzzy logic, makes it possible to identify complex processes both in technology and in economics. The use of neuro-fuzzy systems makes it possible to solve the problem of constructing control systems in conditions of uncertainty on the basis of the available statistical and experimental

---

CMIS-2021: The Fourth International Workshop on Computer Modeling and Intelligent Systems, April 27, 2021, Zaporizhzhia, Ukraine  
EMAIL: flydaiver@gmail.com (S. Ivanov); maxishko@ukr.net (N. Maksyshko); nn\_iva@ukr.net (M. Ivanov)  
ORCID: 0000-0003-1086-0701 (S. Ivanov); 0000-0002-0473-7195 (N. Maksyshko); 0000-0002-1908-0763 (M. Ivanov)



© 2020 Copyright for this paper by its authors.  
Use permitted under Creative Commons License Attribution 4.0 International (CC BY 4.0).  
CEUR Workshop Proceedings (CEUR-WS.org)

data obtained about the control object. It should be noted that the use of only one neural network in the tasks of automated control has a number of disadvantages. This is how the neural network receives information about the control object in the learning process, and this requires statistical data. Therefore, this disadvantage can be eliminated by using fuzzy set structures, which allow for the formalization of fuzzy variables. Therefore, this article is devoted to the actual problem of constructing a neuro-fuzzy control system for non-deterministic objects in real-time systems.

## 2. The purpose of the article

The paper is devoted to the construction of a neuro-fuzzy control system for a non-deterministic object in real time. The paper presents an approach to constructing a model of a neuro-fuzzy control system for non-deterministic objects, as well as the process of implementing a model of an automated control system ANFIS.

## 3. Literature review

Today, in control systems fuzzy sets, the authors Ivanov M., Maksyshko N., Ivanov S. and Terentieva N. applied a method of modeling multidimensional processes [2].

In the works of Casillas J., Cordyn O. [3], Cordyn O., Herrera F. [4], and Espinosa J., Vandewalle J. [5], the problems of tuning fuzzy systems based on rules for linguistic variables and an algorithm for extracting rules are considered.

Authors Wang, D., He, H., Zhao, B. and Liu, D. [6] identified the main advantages of using optimal control based on a neural network (NN) with feedforward.

In the articles of the authors Guillaume S. [7, 8] and Herrera F. [9], the problems of constructing a fuzzy inference system (FIS) for modeling and control process are considered, as well as the use of genetic algorithms for the design of fuzzy systems.

In the work, Anzaklis P.J. [10] considered the issues of hybridization of fuzzy logic systems. The identified shortcomings in the use of a fuzzy inference system are solved on the basis of a neural network that is able to learn and take into account previous knowledge.

In the article, Cui R., Yang C., Li Y., and Sharma S. [11] solved the problem of trajectory tracking and object control in the area of discrete time based on two neural networks (NN). Therefore, the data during the development of the control system must be specified explicitly.

Using a neuro-fuzzy approach eliminates the above problems. Jang J.S.R. in [12] presented an architecture and training procedure, which is based on ANFIS.

The results of the study by Boyacioglu M.A. and Avci D. in [13] showed the ability of the ANFIS system to predict the efficiency of the stock market.

In the works of Takagi T., Sugeno M. [14], a mathematical tool is presented for constructing a fuzzy model of a system in which fuzzy inferences are used. The authors in their works have shown a method for identifying a system using its input-output data.

In the work of Zhang H. and Liu D. [15], the methodology of fuzzy logic is presented and efficiency is proved when working with complex nonlinear systems that contain uncertainties.

New solutions for the use of an artificial neural network and an adaptive neuro-fuzzy inference system were considered in the work of Suparta, W., Alhasa, K. M. [16]. This paper presents the theoretical foundations and explains in detail this method, as well as emphasizes its importance for evaluating the model under study.

Saugat B., Debabrota B., Amit K. and Tibarewala D. [17] examined neural networks and showed that the Adaptive Neural Fuzzy Inference System (ANFIS) works effectively to deal with uncertainties.

The problems of assessing the quality of input signals were considered in the work of Kumarl A. and Qureshi M.F [18]. This paper provides an overview and analyzes of active filter methods. The main goal of this work is to develop a highly efficient system that is integrated with the network. This solution is based on the use of ANFIS, which allows the system to work quickly and give improved results.

Karaboga, D., Kaya, E. [19] considered two groups of ANFIS parameters: premises and consequences. These studies explored hybrid ANFIS training approaches to assess ANFIS training.

#### 4. Building a model of a neuro-fuzzy object control system

To determine the input components of the neuro-fuzzy object control system, the method of system analysis is applied. This method allows you to analyze the mechanisms of interaction of an economic object with the environment. Typical procedures correspond to business processes of non-deterministic discrete objects. The decision to use marketing, resource and production procedures is made based on an analysis of the degree of compliance, in this case, with business processes in an economic entity. This approach combines the advantages of the principle of using typical subsystems of automated control systems and the process approach. To build automated control systems that operate under conditions of random processes, the automated systems approach can be applied. However, for automated control systems it is not always possible to obtain a system of equations that fully described it. Existing automated control systems are conditionally invariant (quasi-invariant) to external factors. Therefore, the classical structural model of a discrete automated control system is usually presented in the following form (Fig. 1.).

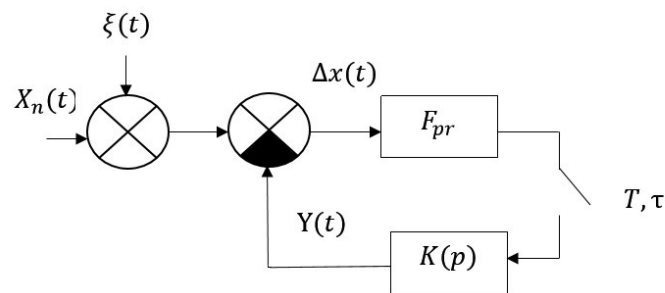

**Figure 1:** Structural model of a discrete quasi-invariant automated control system

The structural model of an automated control system includes a production function and vectors of controlled variables. Automated control system data depends on:

$X_n(t)$  – vectors of input parameters of the automated system;

$F_{pr}$  – object (enterprise) functions;

$\xi(t)$  – vectors of external disturbances on the control system.

It should be noted that during the time  $\Delta t$ , the vector of mismatch  $\Delta x(t)$ , is generated, which is necessary for the analysis and processing of the input data. All components of the structural model of the control system depend on time, which change in accordance with the period of the switch (time sampling). The switch is displayed in a discrete automated control system in the form of a switch with a period  $T$ . This period of time in the system is necessary for the analysis and processing of the initial data from the moment of their arrival to the control of the object. Therefore,  $\tau$  - the duration of pauses will be determined by the time between the arrival of the input data and the control of the object. The closed position of the switch of the automated system characterizes the state when information is provided for making management decisions in accordance with the transmission ratio. In the case of an open switch, the automated system is in watch mode. It should be noted that fluctuations of the input parameters fall into the control system mismatch block and determines the need to transform managerial decisions. In general, the system of automated control of the object should be considered as a set of tasks to be solved. According to the proposed solution in an automated control system in real time, it is proposed to use a neuro-fuzzy control system as a function of the object ( $F_{pr}$ ) and the system's transfer ratio ( $K(p)$ ). The model of a neuro-fuzzy system for automated control of non-deterministic objects is shown in the Figure 2.

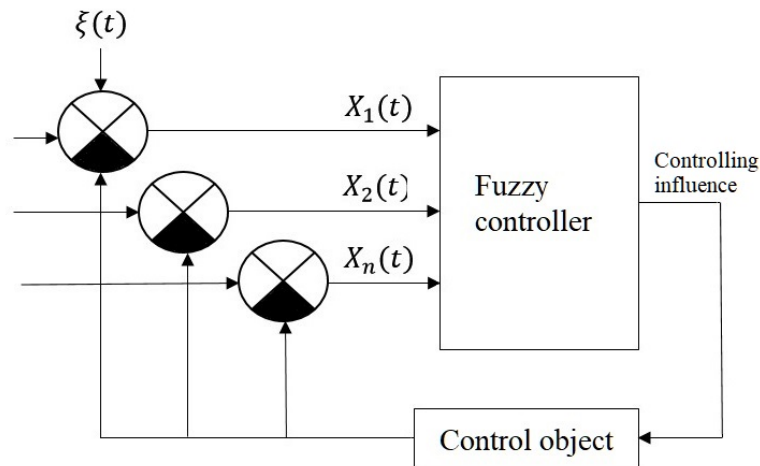

**Figure 2:** Model of a neuro-fuzzy control system for non-deterministic objects

The system ensures the adoption of  $n$  managerial decisions under the condition of fuzzy input values. The adaptation of the system is provided at the stage of training the neural network. The neuro-fuzzy control system is based on the learning process of an artificial neural network (ANN), which allows to define the rules of fuzzy inference (FIS). As soon as the parameters of the fuzzy inference are determined, the neural networks operate as usual. This is an integrated model in which a neural network (ANN) training algorithm is used to determine the parameters of a fuzzy inference system (FIS). Fuzzy inference system and corresponding membership functions. On the other hand, the learning mechanism of a neural network does not depend on statistical information, but is standard for the chosen architecture of an artificial neural network.

The ANFIS model (Adaptive-Neural-Based Fuzzy Inference System) ANFIS with the implementation of the Takagi T., Sugeno M. fuzzy system, which is a five-layer feedforward neural network, is shown in the Figure 3.

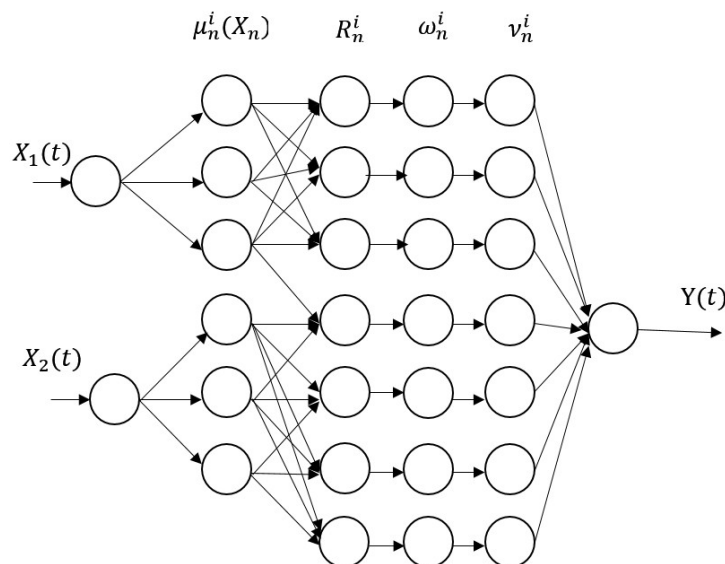

**Figure 3:** Structural view of ANFIS system.

The input values of the model  $X_1$  and  $X_2$  allow you to determine the mismatch between the current and planned value of the variable. The output variable  $Y$  is the control value of the automated system.

The first layer of the ANFIS system allows the definition of fuzzy sets of a set of input quantities. The outputs of the nodes of the layers of this level are the domains of membership functions for certain input values  $\mu_1(X_n)$ .

The second level of the system makes it possible to determine the generated fuzzy rules. At this level, one fuzzy rule will correspond to each layer. The layer of the second level of the system is connected with the nodes of the first level, which form the formation of the corresponding rules. The outputs of the layers in the system are calculated as ratios of the input quantities  $\omega_1$ .

The third level allows you to normalize the degree of rule compliance

$$\bar{\omega}_i = \frac{\omega_i}{\sum \omega_i}, \quad i = 1, \dots, n. \quad (1)$$

In the system, the non-adaptive layer determines the weight value of the execution of the fuzzy rule.

The fourth level of the adaptive system determines the contribution of each fuzzy rule to the value of the output value of the network. The layer of the fourth level determines the contribution of the fuzzy rule to the value of the output value of the system.

The fifth layer forms the value of the magnitude of the control system

$$Y = \sum Y_{t,n}^i. \quad (2)$$

Therefore, the ANFIS automated control system determines that only one fuzzy represents each value set. The training procedure from the ANFIS neural network has no restrictions on the modification of membership functions. To ensure the speed of training the neural network and the adaptability of the software implementation, the model Takagi T., Sugeno M.

The Takagi T., Sugeno M model is based on a high-performance neural network training procedure. The following indicators are selected to build the model:

$Y_{t,n}$  – output value of the control system per year by months  $t : t = 0, 1, \dots, 11$ ;

$x_{t,1}$  – the quantity of the first product sold per week (units);

$x_{t,2}$  – the quantity of the second item sold per week (units);

$x_{t,HR}$  – the amount of human resources that were used to produce goods.

This choice of variables allows you to determine the position of goods on the market and track the current changes in the market. As the output value of the control system, the model can be written in the following form:

$$x_{t,3} = \sum x_{t,HR}.$$

The choice of variables allows determine the position of goods on the market and current changes in the market. As the output value of the control system, the model can be written in the following form:

$$Y_{t,n}^i = a_0 + \beta_1 Y_{t-1,1} + \beta_2 x_{t,1} + \beta_3 x_{t,2} + \beta_4 x_{t,HR}. \quad (3)$$

Further, it can be seen that all variables affect the formation of fuzzy rules. The rules for the Takagi T., Sugeno M. model were constructed according to the following algorithm. The algorithm, which is built of seven fuzzy rules, is as follows:

*The Rule<sup>1</sup> :*

*If* ( $x_{t,2} = A_1$ ) *and* ( $Y_{t-1,1} = B_1$ ) *and* ( $x_{t,1} = C_1$ ) *and* ( $x_{t,HR} = D_1$ ) *Then*

$$Y_t^1 = a_0^1 + \beta_1^1 Y_{t-1,1} + \beta_2^1 x_{t,1} + \beta_3^1 x_{t,2} + \beta_4^1 x_{t,HR}$$

*The Rule<sup>2</sup> :*

*If* ( $x_{t,2} = A_1$ ) *and* ( $Y_{t-1,1} = B_1$ ) *and* ( $x_{t,1} = C_1$ ) *and* ( $x_{t,HR} = D_2$ ) *Then*

$$Y_t^2 = a_0^2 + \beta_1^2 Y_{t-1,1} + \beta_2^2 x_{t,1} + \beta_3^2 x_{t,2} + \beta_4^2 x_{t,HR}.$$

*The Rule<sup>3</sup> :*

*If* ( $x_{t,2} = A_1$ ) *and* ( $Y_{t-1,1} = B_1$ ) *and* ( $x_{t,1} = C_2$ ) *Then*

$$Y_t^3 = a_0^3 + \beta_1^3 Y_{t-1,1} + \beta_2^3 x_{t,1} + \beta_3^3 x_{t,2} + \beta_4^3 x_{t,HR}.$$

*The Rule<sup>4</sup> :*

If  $(x_{t,2} = A_1)$  and  $(Y_{t-1,1} = B_1)$  and  $(x_{t,1} = C_3)$  Then

$$Y_t^4 = a_0^4 + \beta_1^4 Y_{t-1,1} + \beta_2^4 x_{t,1} + \beta_3^4 x_{t,2} + \beta_4^4 x_{t,HR}$$

The Rule<sup>5</sup> :

If  $(x_{t,2} = A_1)$  and  $(Y_{t-1,1} = B_2)$  Then

$$Y_t^5 = a_0^5 + \beta_1^5 Y_{t-1,1} + \beta_2^5 x_{t,1} + \beta_3^5 x_{t,2} + \beta_4^5 x_{t,HR}$$

The Rule<sup>6</sup> :

If  $(x_{t,2} = A_2)$  Then

$$Y_t^6 = a_0^6 + \beta_1^6 Y_{t-1,1} + \beta_2^6 x_{t,1} + \beta_3^6 x_{t,2} + \beta_4^6 x_{t,HR}$$

The Rule<sup>7</sup> :

If  $(x_{t,2} = A_3)$  Then

$$Y_t^7 = a_0^7 + \beta_1^7 Y_{t-1,1} + \beta_2^7 x_{t,1} + \beta_3^7 x_{t,2} + \beta_4^7 x_{t,HR}$$

In the presented rules  $A_1, A_2, A_3, B_1, B_2, C_1, C_2, C_3$  are fuzzy sets, where membership functions are constructed using the built-in algorithm in Matlab. Also, Matlab calculates the coefficients of the equations  $\alpha_0^i, \alpha_1^i, \beta_1^i, \beta_2^i, \beta_3^i, \beta_4^i, i = 1, \dots, 7$ .

Implementation of the ANFIS automated control system model

Matlab applied the implementation of a neuro-fuzzy control system for non-deterministic objects. Matlab allows you to create a model of an adaptive system of neuro-fuzzy inference, as well as perform its training is shown in the Figure 4.

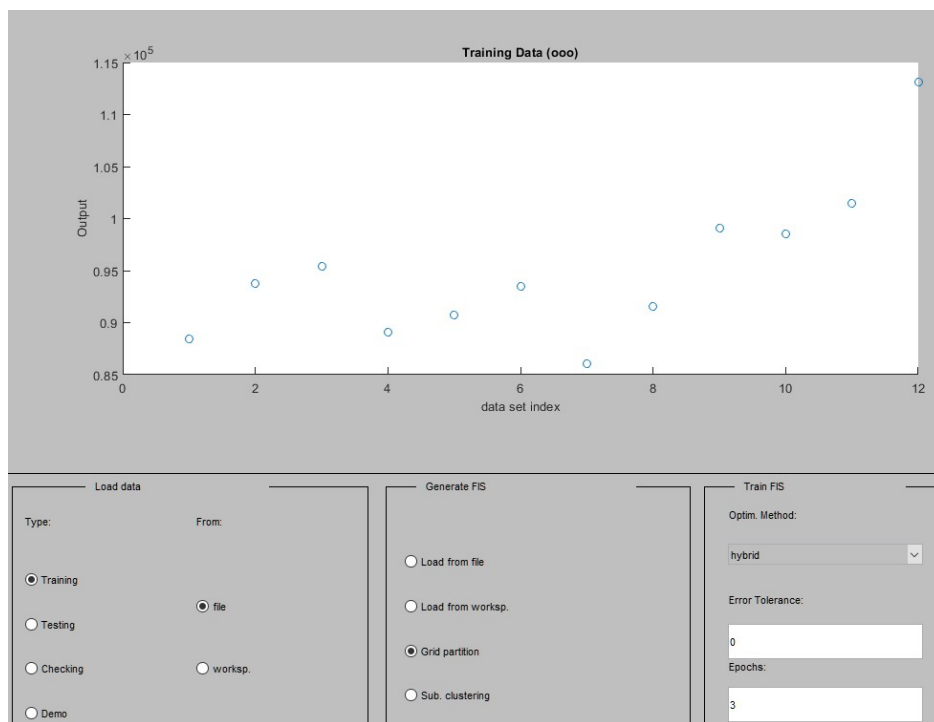

**Figure 4:** Data Entry in ANFIS.

In the process of creating a management system in ANFIS, the statistical values of the demand for goods in the market for the year were used, as well as the optimistic and pessimistic scenarios of the production of goods (Table 1).

At the stage of FIS formation, membership functions were selected and the parameters of the fuzzy inference system were determined. When constructing, Gauss functions (gaussmf) were selected, which made it possible to display the input and output membership functions of the FIS, shown in Figure 5.

**Table 1**  
Matching Statistics to Output Values

The months	Statistical values of the demand for goods on the market for the year, quantity	Optimistic scenario for the production of goods, quantity	Pessimistic scenario for the production of goods, quantity
January	92619	96760	88478
February	97948	102089	93807
March	99593	103734	95452
April	93251	97392	89110
May	94839	98980	90698
June	97591	101732	93450
July	90192	94333	86051
August	95690	99831	91549
September	103223	107364	99082
October	102629	106770	98488
November	105591	109733	101450
December	117227	121368	113086

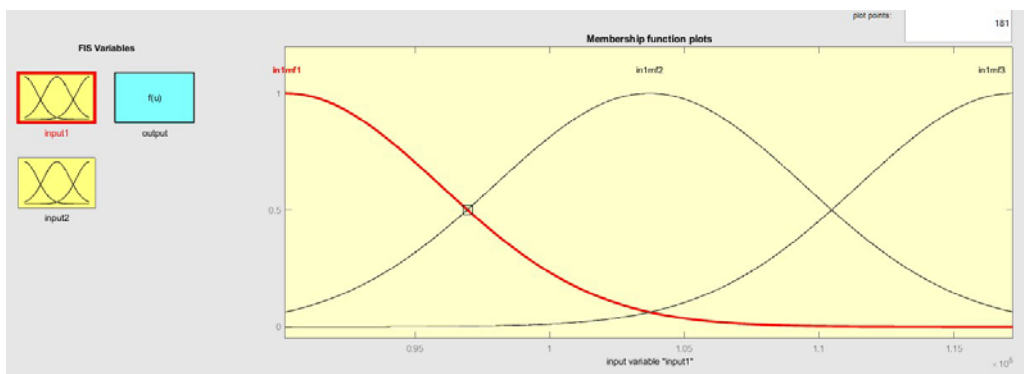

**Figure 5:** Input and output membership functions of FIS.

The next stage is the network training procedure, where a hybrid method is chosen, which is a combination of the least squares method and the inverse gradient decay method. Also, the number of training cycles (Epochs) is set equal to 100, after which the testing procedure follows (Fig. 6).

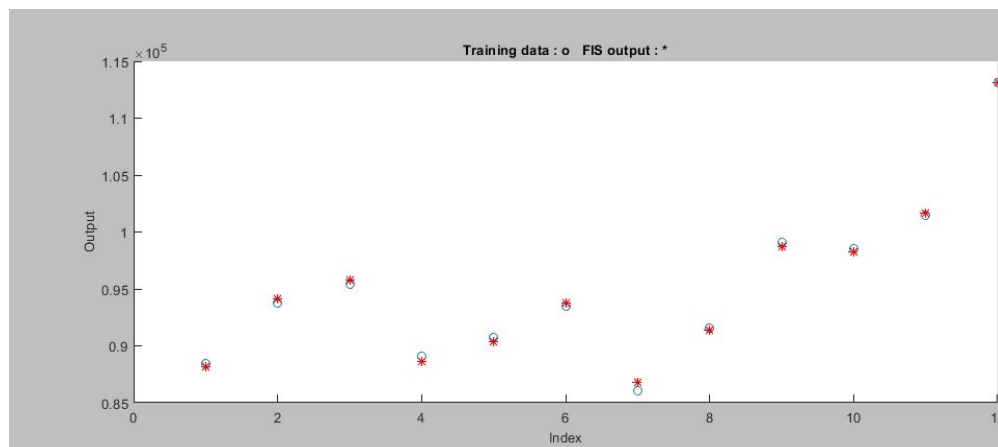

**Figure 6:** The result of the ANFIS system testing process.

The results of constructing the system are presented in the form of the structure of the ANFIS model as follows (Fig. 7).

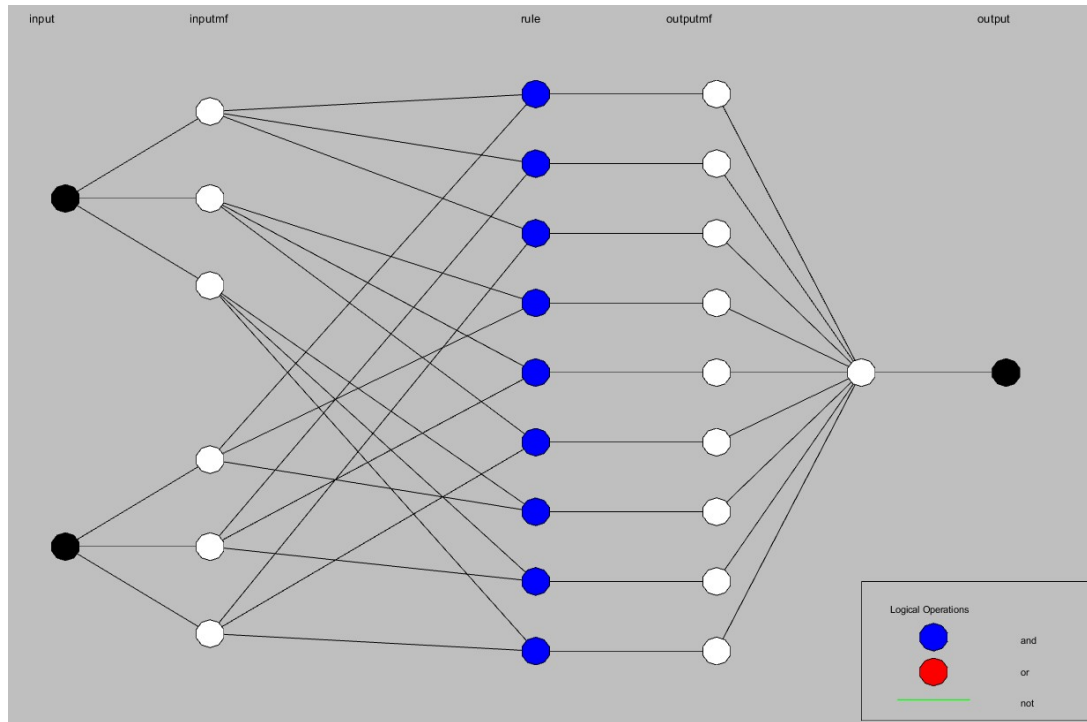

**Figure 7:** The constructed structure of the neuro-fuzzy model ANFIS.

In the process of studying the ANFIS model, the built-in Matlab procedure was used to view the obtained rules of fuzzy inference (Fig. 8).

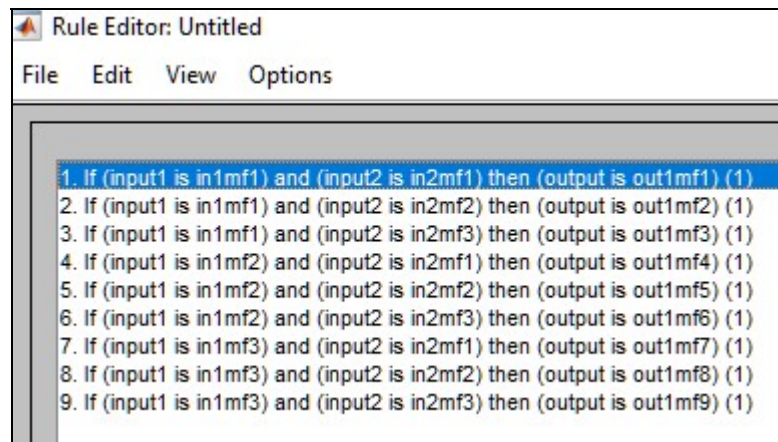
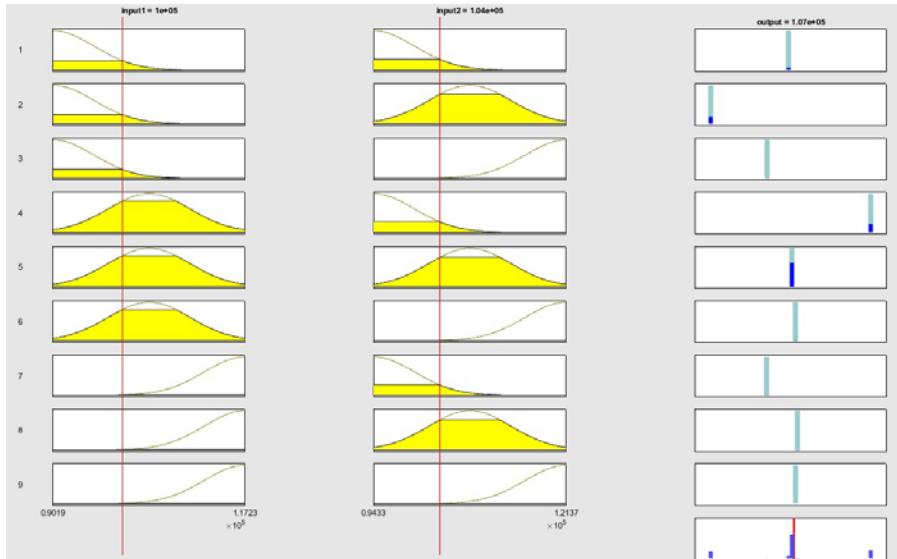

**Figure 8:** Procedure for viewing rules in a fuzzy inference system.

To analyze the results obtained, the following values of the input variables were set: the statistical value of the demand for goods on the market for the year  $1,0 \cdot e^{+5}$  and the optimistic scenario  $1,04 \cdot e^{+5}$ . To obtain this result, the control effect on the production of goods in the ANFIS system will be equal to  $1,07 \cdot e^{+4}$  (Fig. 9).

In addition, Matlab obtained control surfaces of the neuro-fuzzy model ANFIS, which is shown in the Figure 10.





**Figure 9:** The results of the neuro-fuzzy control system.

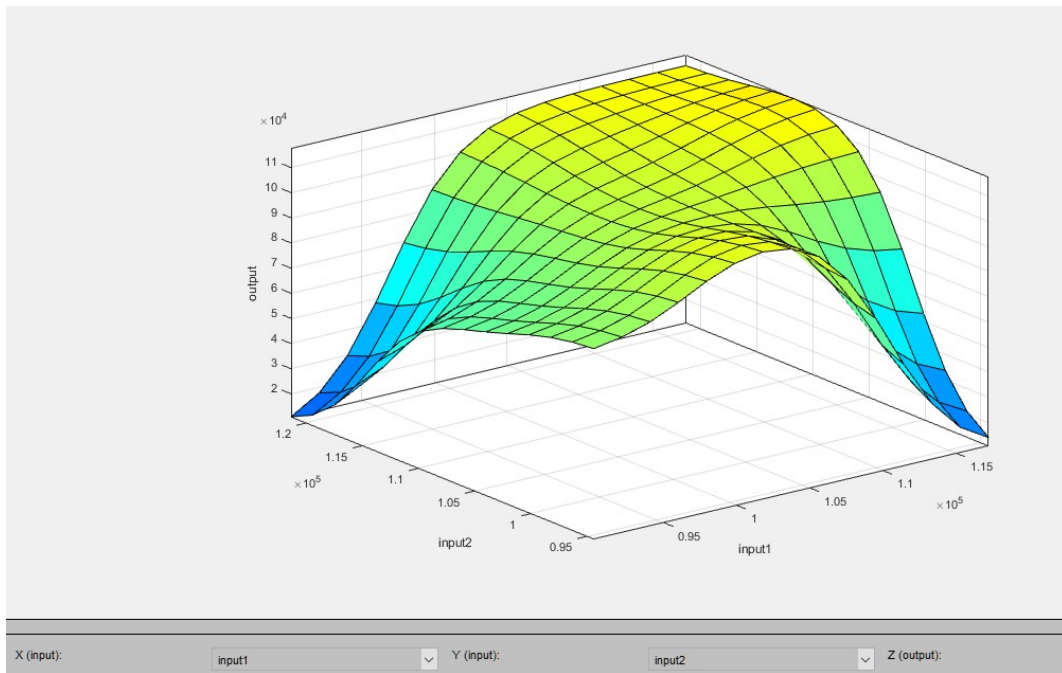

**Figure 10:** ANFIS neuro-fuzzy model control surface.

## 5. Conclusion

A model of a neuro-fuzzy control system for a non-deterministic object in real time is proposed. Structural models of a discrete quasi-invariant automated control system and a neuro-fuzzy control system for non-deterministic objects are considered and analyzed.

The analysis of the ANFIS model, carried out using the fuzzy system Takagi T., Sugeno M. An algorithm constructed from 7 fuzzy rules is considered. The article presents a technique for implementing a neuro-fuzzy control system for non-deterministic objects using Matlab.

Matlab made it possible to create a solution for an adaptive system of neuro-fuzzy inference, as well as carry out procedures for its training. The paper presents the results of the work of an adaptive neuro-fuzzy control system for non-deterministic objects.

## 6. References

- [1] P.C. Chang, C.Y. Fan, A Hybrid System Integrating a Wavelet and TSK Fuzzy Rules for Stock Price Forecasting, *IEEE Transactions on Systems, Man, and Cybernetics* 38(6) (2008) 802–815. doi:10.1109/TSMCC.2008.2001694.
- [2] M. Ivanov, N. Maksyshko, S. Ivanov, N. Terentieva, Intelligent Data Analysis in HR Process Management, in: *Proceedings of The Third International Workshop on Computer Modeling and Intelligent Systems (CMIS-2020)*, volume 2608 of *CEUR Workshop Proceedings CEUR Workshop Proceedings*, CEUR-WS, Zaporizhzhia Ukraine, 2020, pp. 754-768.
- [3] J. Casillas, O. Cordyn, M.J. del Jesus, F. Herrera, Genetic tuning of fuzzy rule deep structures preserving interpretability and its interaction with fuzzy rule set reduction, *IEEE Transactions on Fuzzy Systems* 13 (2005) 13–29. doi:10.1109/TFUZZ.2004.839670.
- [4] O. Cordyn, F. Herrera, P. Villar, Generating the knowledge base of a fuzzy rule-based system by the genetic learning of data base, *IEEE Transactions on Fuzzy Systems* 9 (2001) 667–674. doi:10.1109/91.940977.
- [5] J. Espinosa, J. Vandewalle, Constructing fuzzy models with linguistic integrity from numerical data-AFRELI algorithm, *IEEE Transactions on Fuzzy Systems* 8 (2000) 591–600. doi:10.1109/91.873582.
- [6] D. Wang, H. He, B. Zhao, D. Liu, Adaptive near-optimal controllers for nonlinear decentralised feedback stabilisation problems, *IET Control Theory Appl.* 11(6) (2017) 799–806. doi:10.1049/iet-cta.2016.1383.
- [7] S. Guillaume, Designing fuzzy inference systems from data: an interpretability-oriented review, *IEEE Transactions on Fuzzy Systems* 9 (2001) 426–443. doi:10.1109/91.928739.
- [8] S. Guillaume, B. Charnomordic, Generating an interpretable family of fuzzy partitions from data, *IEEE Transactions on Fuzzy Systems* 12 (2004) 324–335. doi:10.1109/TFUZZ.2004.825979.
- [9] F. Herrera, Genetic fuzzy systems: taxonomy current research trends and prospects, *Evolutionary Intelligence* 1 (2008) 27–46. doi:10.1007/s12065-007-0001-5.
- [10] P.J. Antsaklis, *Neural Networks in Control Systems*, Guest Editor's Introduction, *IEEE Control Systems Magazine* 10(3) (1990) 3-5. doi:10.1109/72.80237.
- [11] R. Cui, C. Yang, Y. Li, S. Sharma, Adaptive Neural Network Control of AUVs With Control Input Nonlinearities Using Reinforcement Learning, *IEEE Transactions on Systems, Man, and Cybernetics: Systems* 47(6) (2017) 1019–1029. doi:10.1109/TSMC.2016.2645699
- [12] J.S.R. Jang, ANFIS: Adaptive-Network-Based Fuzzy Inference System, *IEEE Transactions on Systems, Man, and Cybernetics* 23(3) (1993) 665–685. doi:10.1109/21.256541.
- [13] M.A. Boyacioglu, D. Avci, An Adaptive Network-based Fuzzy Inference System (ANFIS) for the Prediction of Stock Market Return: The Case of the Istanbul Stock Exchange, *Expert Systems with Applications* 37(12) (2010) 7908–7912. doi:10.1016/j.eswa.2010.04.045.
- [14] T. Takagi, M. Sugeno, Fuzzy Identification of Systems and its Applications to Modeling and Control, *IEEE Transactions on Systems, Man, and Cybernetics* 1 (1985) 116–132. doi:10.1109/TSMC.1985.6313399
- [15] H. Zhang, D. Liu, *Fuzzy Modeling and Fuzzy Control*, Springer Science & Business Media, 2006. doi:10.1007/978-0-8176-4539-7.
- [16] W. Suparta, K. M Alhasa., *Modeling of Tropospheric Delays Using ANFIS*, Springer International, 2016. doi:10.1007/978-3-319-28437-8
- [17] B. Saugat, B. Debabrota, K. Amit, D. N. Tibarewala, Interval type-2 fuzzy logic based multiclass ANFIS algorithm for realtime EEG based movement control of a robot arm, *Robotics and Autonomous Systems* 68 (2015) 104–115. doi:10.1016/j.robot.2015.01.007.
- [18] A. Kumar1, M. F. Qureshi, Power quality improvement in pv grid connected system by using active filter and ANFIS based MPPT, *International Journal of Recent Scientific Research* 9 (2018) 29074-29081. doi:10.24327/ijrsr.2018.0910.2788.
- [19] D. Karaboga, E. Kaya, Adaptive network based fuzzy inference system (ANFIS) training approaches: a comprehensive survey, *Artif Intell Rev* 52 (2019) 2263–2293. doi:10.1007/s10462-017-9610-2.