

# Electrical probe-signal processing and criterion for the determination of time parameters of the teeth filling material polymerization process in dentistry

Vyacheslav Nykytyuk<sup>a</sup>, Vasyl Dozorskyi<sup>a</sup>, Nataliia Kunanets<sup>b</sup>, Volodymyr Pasichnyk<sup>b</sup>, Oleksandr Matsiuk<sup>a</sup> and Ihor Bodnarchuk<sup>a</sup>

<sup>a</sup> Ternopil Ivan Puluj National Technical University, Ruska str., 56, Ternopil, 46001, Ukraine

<sup>b</sup> Lviv Polytechnic National University, St. Bandera str., 12, Lviv, 79013, Ukraine

## Abstract

The criterion for the determination the time of polymerization process termination in dentistry for teeth filling material from light cured composites based on the processing of electrical probe-signal, which is the part of ultraviolet radiation reflected from the polymerized material surface. Due to this radiation the actual polymerization of this material is taken place. While presenting the electrical probe-signal in the form of piecewise stationary random process it is proposed to determine the time of composite polymerization process by calculating the average estimates of the signal dispersion within the sliding window translations, and to use the values of the obtained estimates as a criterion

## Keywords 1

criterion, electrical probe-signal, piecewise stationary random process, composite dental material

## 1. Introduction

Along with diagnostic, therapeutic and reconstructive dentistry, the restorative one, which consists particularly in the restoration of damaged hard tooth tissues is widely used at present. The prime cause of such damage is caries - it is the gradual destruction of hard tooth tissues - enamel adenine, accompanied by demineralization, proteolysis and formation of carious cavities under the action of endo- and exogenous factors [1, 2, 3, 4]. The caries disease level of population in different regions of Ukraine reaches 98%, according to WHO statistical data is 95%. Depending on the disease state and form, the treatment mode of teeth carious lesion is chosen, remineralizing therapy is predominant method, but if mid-stage lesion is reached, tooth filling is performed. However, the percentage of tooth filling destruction and loss, which causes the need for patient repeated visits to dental institutions, remains high. The main reasons of unsatisfactory tooth filling state and its loss are often as follows: low quality of the applied filling materials, their incorrect selection, and mostly non-observance of decay cavities filling method related to the selection of filling material type and keeping the technology performance. For decay cavities filling the composites (composite materials) are used. These materials are heterophase materials, separate components of which perform specific functions, providing such materials properties that are not possessed by each component separately [1, 2, 3, 4, 5, 6]. At present polymerization of the most common types of composites is carried out by irradiation with 380-500 nm wavelength. The dominant characteristic of such materials is strength and polymerization, as these indicators depend on the reliability and durability of tooth filling, etc.

---

IDDM-2021: 4th International Conference on Informatics & Data-Driven Medicine, November 19–21, 2021 Valencia, Spain

EMAIL: slavikvv89@gmail.com(A. 1); dozorskyi@tntu.edu.ua (A. 2); nek.lviv@gmail.com(A. 3); vpasichnyk@gmail.com (A. 4); oleksandr.matsiuk@gmail.com (A. 5); bodnarchuk.io@gmail.com (A. 6);

ORCID: 0000-0003-1547-8042 (A. 1); 0000-0001-6744-3015 (A. 2); 0000-0003-3007-2462 (A. 3); 0000-0002-5231-6395 (A. 4); 0000-0003-0204-3971 (A. 5); 0000-0003-1443-8102 (A. 6);

© 2021 Copyright for this paper by its authors.

Use permitted under Creative Commons License Attribution 4.0 International (CC BY 4.0).

CEUR Workshop Proceedings (CEUR-WS.org)



In order to obtain high quality tooth filling for hermetic decay cavity coverage, it is important to ensure the optimal time for tooth filling materials irradiation, since this time reduction results in the deterioration of tooth filling quality, and its increase - to negative affect on the surface of internal oral cavity, salivary glands functioning, etc. Therefore, an important technical problem is to provide the possibility of automated control of filling materials polymerization time in activating lamps - devices for tooth fillings photopolymerization, particularly determining the time moment of polymerization process termination in order to achieve optimal operating parameters of the tooth filling.

## **2. State of research and ways of the problem solving**

In the market of dental equipment there are no technical means that make it possible to control the tooth filling material polymerization time. Evaluation of the tooth filling materials strength in dentistry is carried out by methods determined by international standards [7, 8] in accordance with their type. However, such methods are destructive and after their application the subsequent use of tooth filling material is impossible. Also, such methods do not allow the rapid evaluation of the materials strength directly in the process of tooth filling formation. Therefore, it is important to develop the non-destructive method for determining the tooth filling material strength. On the basis of this method it would be possible to evaluate the time parameters of polymerization process and determine its optimal duration.

One of such methods is that one published in paper [9]. It is based on the registration of the signal resulting from the conversion of the signal reflected from the surface layer of the radiation dental material into the voltage change signal of photoelectrical converter - photodiode (this signal is called an electrical probe-signal). In this case, the tooth filling material is considered as energy-active object that absorbs the energy of emitting signal to ensure the polymerization process, and changes in energy characteristics of the electrical probe-signal make it possible to estimate the amount of energy absorbed during the tooth filling material polymerization process and to evaluate the process course in time for the determination of the optimal time of tooth filling material irradiation.

To ensure the possibility of evaluating the polymerization process and reduce the influence of external factors (external background radiation), the expediency of irradiating the filling material in radiation flashes with predetermined parameters is substantiated in paper [9]. Additionally, the relevance of photopolymer material irradiation by pulsating radiation for reducing the value of polymerization shrinkage, reducing the percentage of cracking of the final product – tooth filling (by reducing the internal stresses level), and providing smooth and uniform (along tooth filling volume) composite material polymerization is shown [9].

However, it is necessary to develop a method of processing the electrical probe-signal to determine the optimal duration of tooth filling material irradiation based on an adequate mathematical model of such a signal.

## **3. Models and methods**

Let us consider the features of the electrical probe-signal in the form of deterministic process. Analyzing the structure of such signal, the implementation of one pulse of the electrical probe-signal can be presented as the transient process containing information about the activation and progress of the tooth filling material polymerization process within the given time interval - the radiation pulse duration. In this case, the transition process is considered as a process of change in time of dynamic system coordinates. This process occurs during the transition from one steady state to another - the initiation and the actual polymerization process. In the tooth filling material (dynamic system), the transition process occurs under excitatory influence - radiation, which changes the state, structure and parameters of the system.

Taking into account the fact that the irradiation of the filling material is performed by pulses, the transient processes will be manifested within each pulse. And actually the electrical probe-signal can be considered as a pulse periodic process.

However, in the tooth filling material polymerization process in time, the parameters of each separate transition process are variable and are determined by the type of tooth filling material,

thickness of its application, irradiator parameters and irradiation angle, external factors such as air pressure, humidity, temperature, backlight level, etc. All these factors result in the occurrence of the random form of tooth filling material polymerization process within each irradiation pulse the availability of additional non-informative components (noise).

While presenting the electrical probe-signal in the form of stationary random process, it is determined that such mathematical model takes into account the probabilistic structure of this type of signals but has no means to estimate the time-phase structure of such signals which is important for the identification of tooth filling process dynamics and determination of the time of polymerization process termination.

Considering this formation mechanism, the electrical probe-signal is presented as a set of impulses shifted in time relatively to each other for constant period  $T = T_{Flash}$  in the following form:

$$\xi(t) = \sum_{k \in Z} \chi_{D_k}(t) \cdot \xi_{Flash_k}(t - kT), \quad t \in R \quad (1)$$

where  $\chi_{D_k}(t) = \begin{cases} 1, & \text{where } t \in D_k \\ 0, & \text{where } t \notin D_k \end{cases}$  is the indicator function of  $D_k$  set;

$D_k = [kT, (k+1)T)$  is the time range the duration of k-th response  $\xi_{Flash_k}(t), t \in [0, T)$ ;  $T$  - is the duration of one flash of electrical probe-signal.

Such representation of the electrical probe-signal takes into account in its structure the combination of periodicity properties with stochasticity, and thus makes it possible to consider and evaluate the statistical interrelationship between different reflection pulses from the tooth filling material of the same series of observations, which is impossible in case of traditional representing similar reactions series in the form of implementations ensemble.

As a result of morphological analysis of electrical probe-signal structure and the nature of its individual impulses generation, it is determined that the adequate mathematical model of such class of signals should take into account the property of periodicity and stochasticity.

In terms of the energy theory of stochastic signals, such properties are taken into account by the mathematical model in the form of periodically correlated random process. By the definition of periodically correlated random process, it is the process which correlation function meets the requirements of conditions  $r_\xi(t+T, s+T) = r_\xi(t, s)$ ,  $T > 0$ , for all  $t, s \in R$  and  $\frac{1}{T} \int_0^T r_\xi(t, t) dt < \infty$ .

Considering the reflection of each flash from the tooth filling material as the implementation of periodically correlated random process, at time intervals  $[kT, (k+1)T)$ , we can interpret the set as the implementation of periodically correlated random process representation by translation components:

$$\xi(t) = \sum_{p \in Z} \sum_{k \in N} a_k(p) \Phi_k(t - pT) \quad (2)$$

where  $a(p) = [a_k(p)]_{k \in N}, p \in Z$  is the vector stationary sequence;

$\{\Phi_p(t), p \in N, t \in [pT, (p+1)T)\}$  is the translation basis in functional space  $L^2(0, T)$ ;  $\{\alpha(n), n \in Z\}$  is the sequence of translational stationary components.

Representation by translation components is adequate to the pulse signal formats and is effective in the modeling of electrical probe-signal for the evaluation of polymerization process dynamics. However, for the task of determining the time of polymerization process termination, we can use the representation of the electrical probe-signal in the form of a piecewise stationary random process (as a partial case of periodically correlated random process) and apply statistical evaluation methods for processing. If we define the changes in the structure of electrical probe-signal pulses in the process of dental material polymerization as disorder, then the purpose of such signal processing is to establish the time of disorder termination. In paper [10], the model of piecewise stationary random process in the form of random vector process  $\Xi_n(t) = (\xi_1(t), \xi_2(t), \dots, \xi_n(t))$  is given. If such process is given on interval  $t \in [a, b]$  and the sequence of sets  $B_k, \vec{\tau} \quad k = \overline{1, n}$  is the division of this interval by points  $t_1, t_2, \dots, t_k$ , and  $I_{B_k}(t)$  is the indicator function of set  $B_k$ , is such that  $I_{B_k}(t) = \begin{cases} 0, & t \notin B_k; \\ 1, & t \in B_k, \end{cases}$  then

the random process in the form  $\xi_{\Sigma}(t) = \sum_{k=1}^n \xi_k(t) I_{B_k}(t)$  is called the disorder process, and moments  $t_1, t_2, \dots, t_n$  are disorder moments [10].

In order to determine the time of disorder termination, it is proposed to use the method based on electrical probe-signal processing within the window that is transmitted in time (sliding window). In this case, within the window width it is necessary to evaluate the probabilistic characteristics of the signal during the tooth filling material polymerization and at the end of this process. It is assumed that statistical estimates of electrical probe-signal calculated within each impulse of such signal are almost the same for the state of filling material polymerization process termination and differ for various impulses corresponding to this process. Comparing the estimates of probabilistic characteristics of the samples from the signal for these two states, it is necessary to substantiate the criterion by which it would be possible to distinguish these two states.

#### 4. Experiments and results

To register the electrical probe-signal of material polymerization, the experiment structural scheme is proposed. This scheme is shown in Fig. 1.

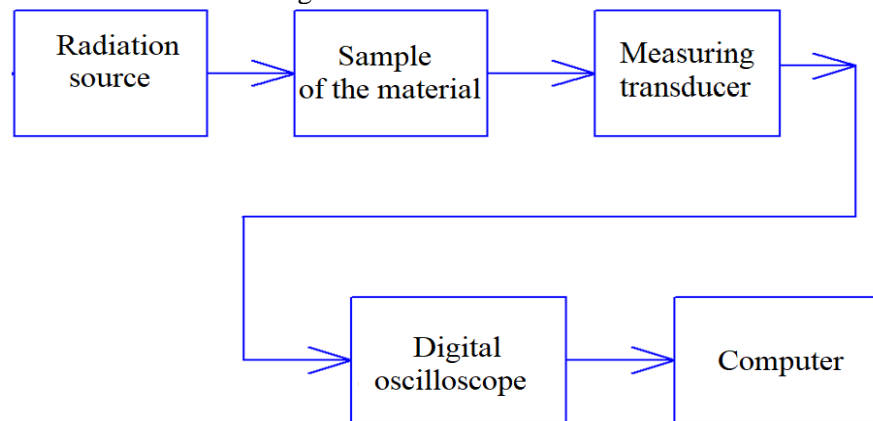

**Figure 1:** The structural scheme of the experiment of electrical probe-signal registration

According to Fig. 1, the sample material is irradiated; the reflected light is converted by measuring transducer into electrical signal, registered and digitized by digital oscilloscope. The digitized signal is fed to the computer for processing.

The experimental selection of electrical probe-signals by means of installation, which structure is shown in Fig. 2 is performed.

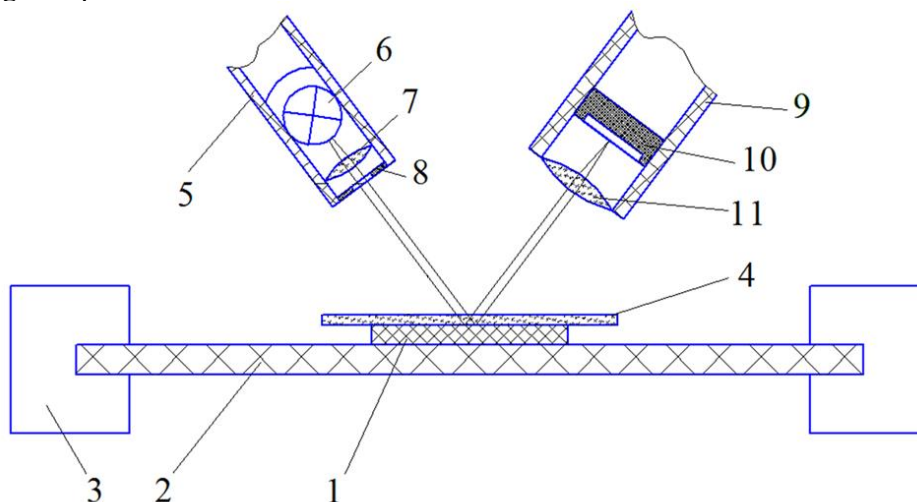

**Figure 2:** The structure of the installation for the selection of material polymerization electrical probe-signal

According to Fig. 2, the tooth filling material 1 (nanocomposite meets the international standards: ISO 9001, ISO 13485 CE Marked Products) is applied to base 2, which is fixed to frame 3. On the top, the laboratory cover glass 4, used for anti-reflective microscopes is applied to ensure uniform material distribution 1 along the base surface 2. Number 5 indicates the source of ultraviolet radiation, containing helio lamp 6, lens 7, designed to create parallel beam and diaphragm 8, aimed to emit the beam of the given thickness. The lamp power source is not shown. Number 9 indicates the semiconductor photodiode 10 and collecting lens 11.

In this work Woodpeker Led B is used for irradiation. Its irradiation intensity is 1100 Lx and the wavelength is 350-500 nm. At this stage, “Master-Lux” device is used as a measuring transducer, which is designed to control the radiation intensity of photopolymer lamps widely used in dentistry. The ADC of digital oscilloscope ATEN ADS 1102 CAL (complies with international standards: ISO-9001) was used to digitize the received electrical probe-signal. When recording signals, the sampling frequency of the ADC was 5 kHz, bit rate - 8 bits. The recorded signals were processed on a personal computer in the Matlab environment. An example of the sample from experimentally recorded electrical probe-signal is shown in Fig. 3.

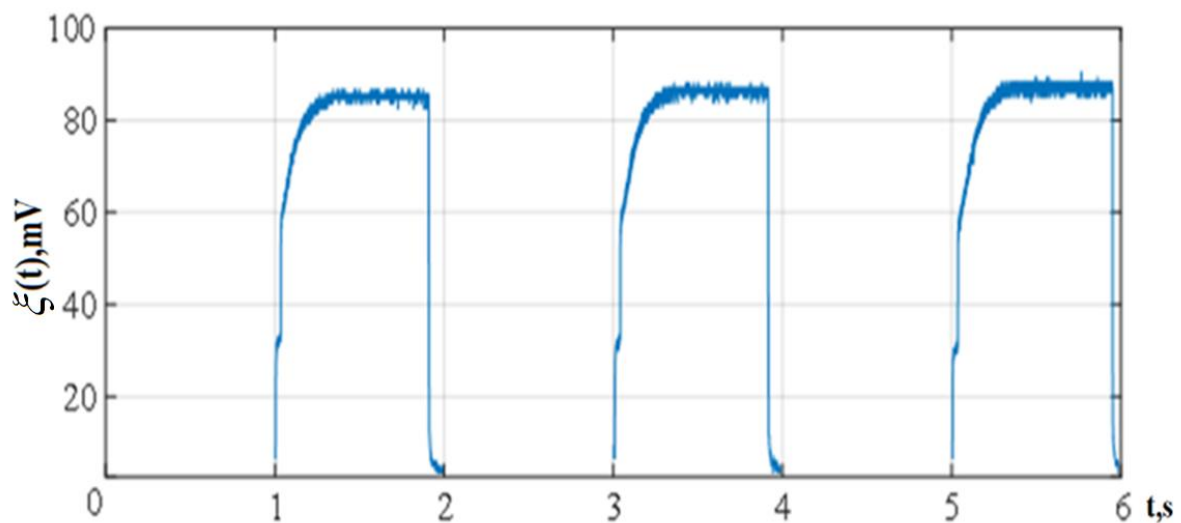

**Figure 3:** Sampling from the implementation of recorded electrical probe-signal

It is evident from Fig.3, that the structure of electrical probe-signal is also pulsating, its changes contain information about the course of tooth filling material polymerization process. In this case, the information will be contained in the change of time and amplitude parameters of the pulses vertices, and this change will be minimal for the areas of the electrical probe-signal, which correspond to the polymerization process termination.

Also, using the proposed method of electrical probe-signal processing within the sliding window, it is necessary to choose the criteria for establishing the time of polymerization process termination based on the results of such signal processing.

To establish the time of tooth filling material polymerization process termination, it is necessary to substantiate the criterion that would be sensitive to changes in the shape of pulse vertices of the electrical probe-signal and would allow to determine the time of pulses with minimal change of their energy parameters at the end of polymerization process in comparison with the impulses selected during the polymerization process. For this purpose, assuming that electrical probe-signal is the piecewise stationary random process [10, 11, 12] within each individual period, it is proposed to evaluate the signal statistics within the time interval equal to the signal period - within the sliding window. The window is broadcast in time to constant value equal to the signal period (i.e. the next and previous windows do not overlap). The view of electrical probe-signal implementation and the motion of sliding window along it are shown in Fig. 4. In this case,  $T_1, T_2, T_3, \dots, T_n$  are denoted as 1,2,3,... n-th window within which the signal is processed.

It is assumed that in the area of electrical probe-signal corresponding to the dental material polymerization process, the statistical estimates calculated within the previous and next windows

differ significantly, while in the signal areas corresponding to polymerization process termination, these estimates differ slightly.

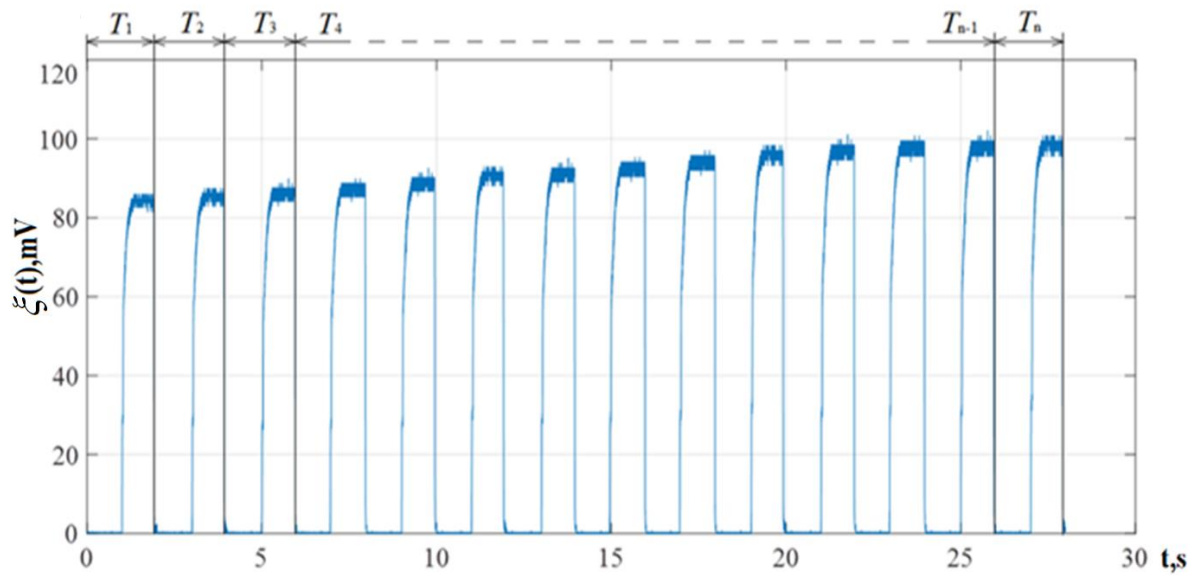

**Figure 4:** Implementation of electrical probe-signal and the motion of sliding window

In order to substantiate the criterion of determining the time of the termination of tooth filling material polymerization process, the calculations of maximum value, mathematical expectation and dispersion of electrical probe-signal within the sliding window are carried out. The values of these estimates are listed in Table 1.

**Table 1**

The values of the estimates of electrical probe-signal, which were calculated within the sliding window

No of sliding window	Parameter which is calculated within the sliding window		
	Maximum value, $\max(\xi_n)$	Mathematical expectation $m(\xi_n)$	Dispersion $d(\xi_n)$
1	85.9680	36.1915	1.6183·10 <sup>-6</sup>
2	87.4500	36.6173	1.6585·10 <sup>-6</sup>
3	89.8888	38.5127	1.7054·10 <sup>-6</sup>
4	89.9200	41.3688	1.7588·10 <sup>-6</sup>
5	92.5915	39.6553	1.8105·10 <sup>-6</sup>
6	92.8840	38.8626	1.8730·10 <sup>-6</sup>
7	95.0940	40.7133	1.9107·10 <sup>-6</sup>
8	95.3540	43.8397	1.9800·10 <sup>-6</sup>
9	97.0336	44.6128	2.0502·10 <sup>-6</sup>
10	98.3180	41.1300	2.0988·10 <sup>-6</sup>
11	101.1000	43.2886	2.1589·10 <sup>-6</sup>
12	100.7880	46.3542	2.2103·10 <sup>-6</sup>
13	102.1010	43.7212	2.2014·10 <sup>-6</sup>
14	100.7880	42.1741	2.2045·10 <sup>-6</sup>

Fig. 5 – Fig. 7 show the curves reflecting the changes in the values given in Table 1 of the estimates of electrical probe-signal in time, which corresponds to the time of tooth filling material polymerization process (Fig. 4).

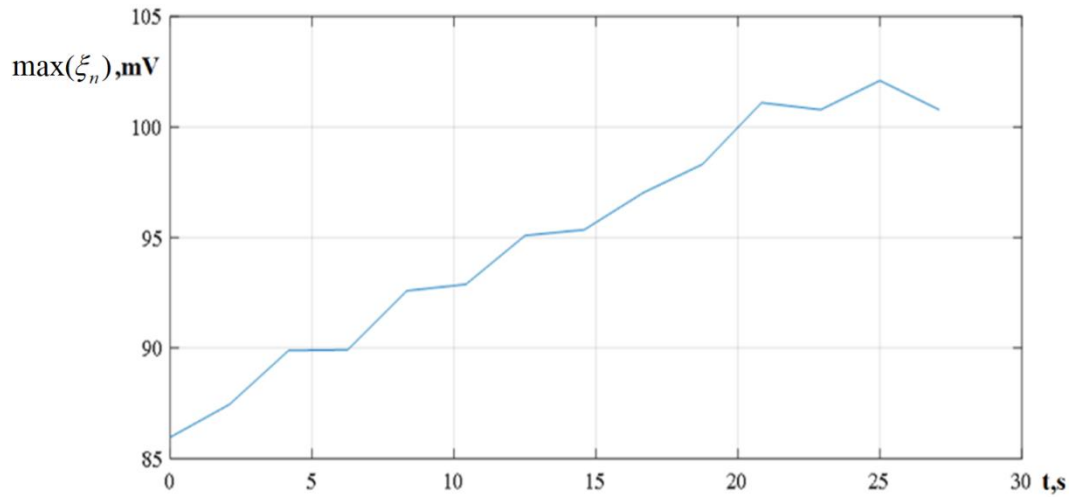

**Figure 5:** Curve showing changes in maximum value of electrical probe-signal within the sliding window, plotted along the time axis of tooth filling material polymerization process

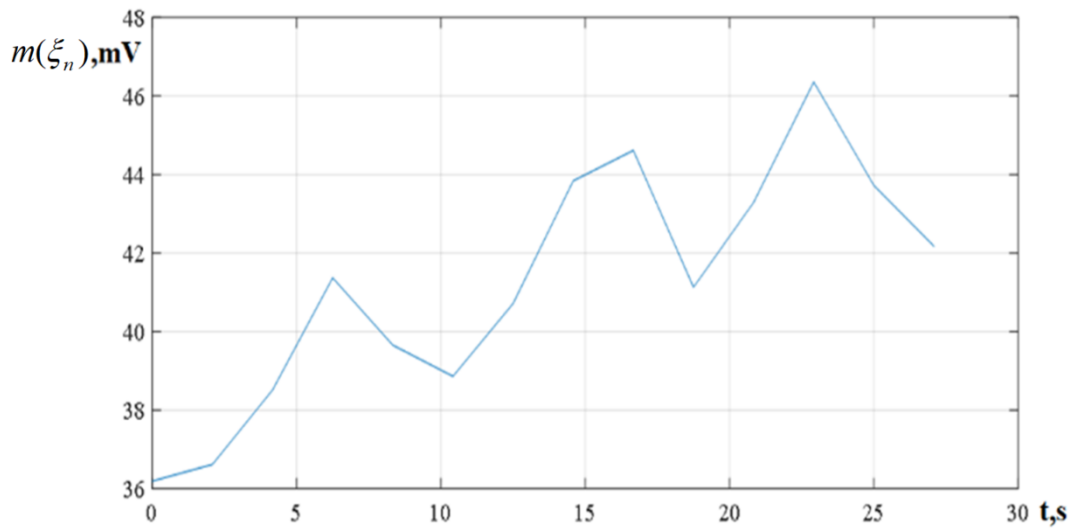

**Figure 6:** Curve showing changes in mathematical expectation of electrical probe-signal within the sliding window, plotted on the time axis of tooth filling material polymerization process

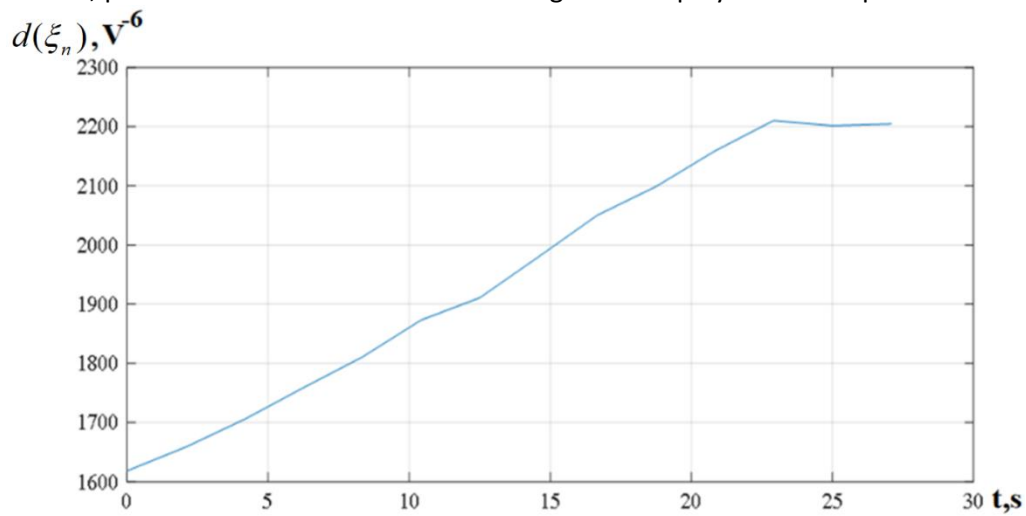

**Figure 7:** Curve showing changes in dispersion of electrical probe-signal within the sliding window, plotted on the time axis of tooth filling material polymerization process

It is evident from Fig.5 - Fig.7 that in the time interval 23–28 s, which corresponds to polymerization process termination, the curve of dispersion change is almost linear with a small change in values, and in interval 0–23 s, which corresponds to polymerization process, this the curve is almost uniform with significant change in values.

Comparison of electrical probe-signal implementation (Fig. 4) and calculated from it dispersion estimates using the sliding window is shown in Fig. 8. The vertical line in time  $t_{STOP}$  denotes the time of termination of tooth filling polymerization process, which corresponds to the beginning of linear section of the disperse change curve with a small change in its values.

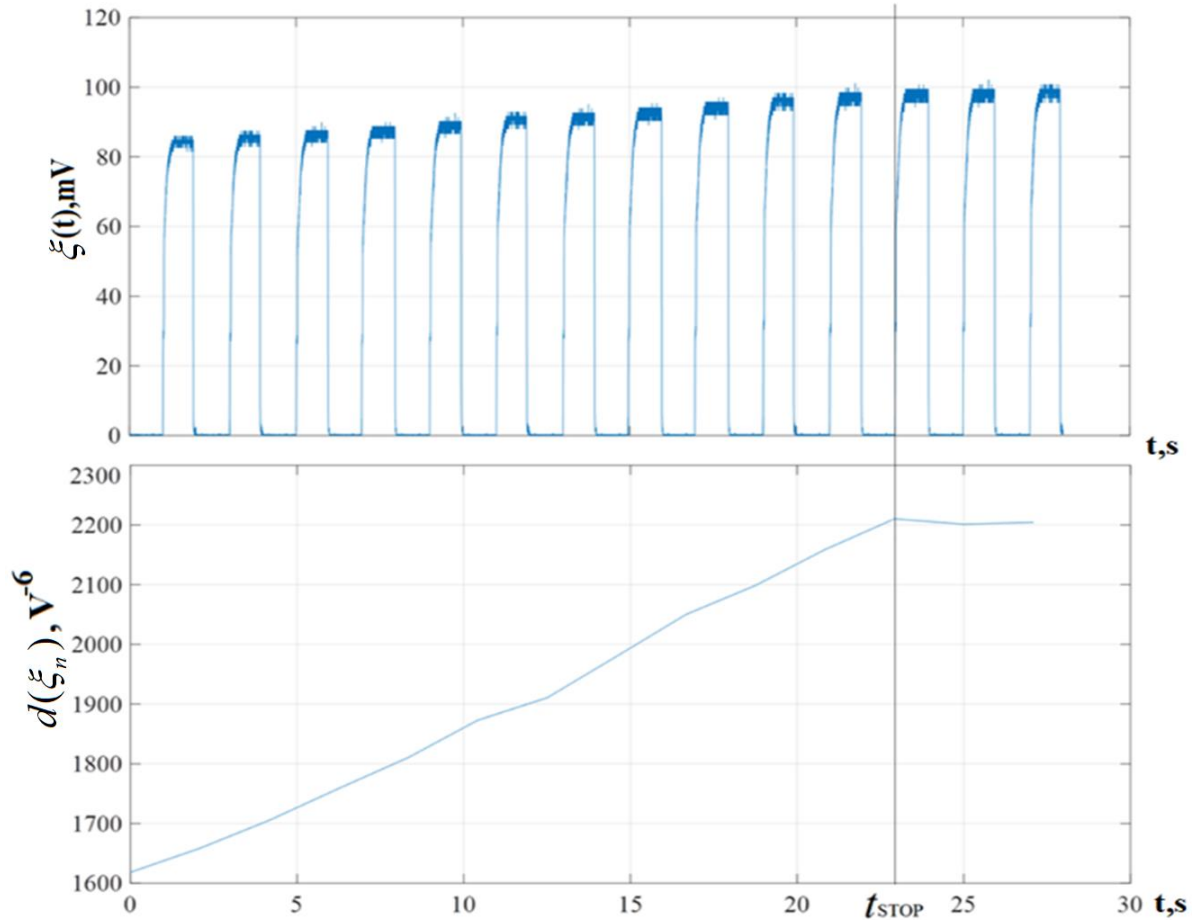

**Figure 8:** Comparison of electrical probe-signal implementation and the dispersion estimates calculated from using the sliding window

In order to establish the time of termination of tooth filling material polymerization process, it is proposed to calculate the difference  $\Delta$  between the values of dispersion estimates of electrical probe-signal calculated within the next and previous windows, which can be defined as the variation of estimates of electrical probe-signal dispersions within the sliding window:

$$\Delta_m = d_n - d_{n-1} \quad (3)$$

where  $m$  is the number of the calculated dispersion difference,  $n$  is the number of sliding window

Dispersions  $d_1-d_{14}$  shown in Fig. 9 are the values of dispersion estimates of electrical probe-signal, calculated within 14 translations of the sliding window,  $\Delta_1-\Delta_{13}$  are the values of differences between the next and previous values of dispersion estimates.

It is found that in the areas of electrical probe-signal corresponding to tooth filling material polymerization process, the difference between the dispersion values  $\Delta$  polymerization are:

$$\Delta_{\text{polymerization}} = (55 \pm 10\%) \mu\text{V}, \quad (4)$$

and in the areas corresponding to the termination of tooth filling material polymerization process, this difference  $\Delta_{STOP}$  is:

$$\Delta_{STOP} = (6 \pm 10\%) \mu\text{V}. \quad (5)$$



Since  $\Delta_{\text{polymerization}}$  and  $\Delta_{\text{STOP}}$  differ by about an order of magnitude, value  $\Delta$ , which can be defined as the variation of dispersion estimates of electrical probe-signal within the sliding window, is sensitive to changes in the state of tooth filling process - composite polymerization and this process termination, and can be used as a criterion for the determination of the time of polymerization process termination.

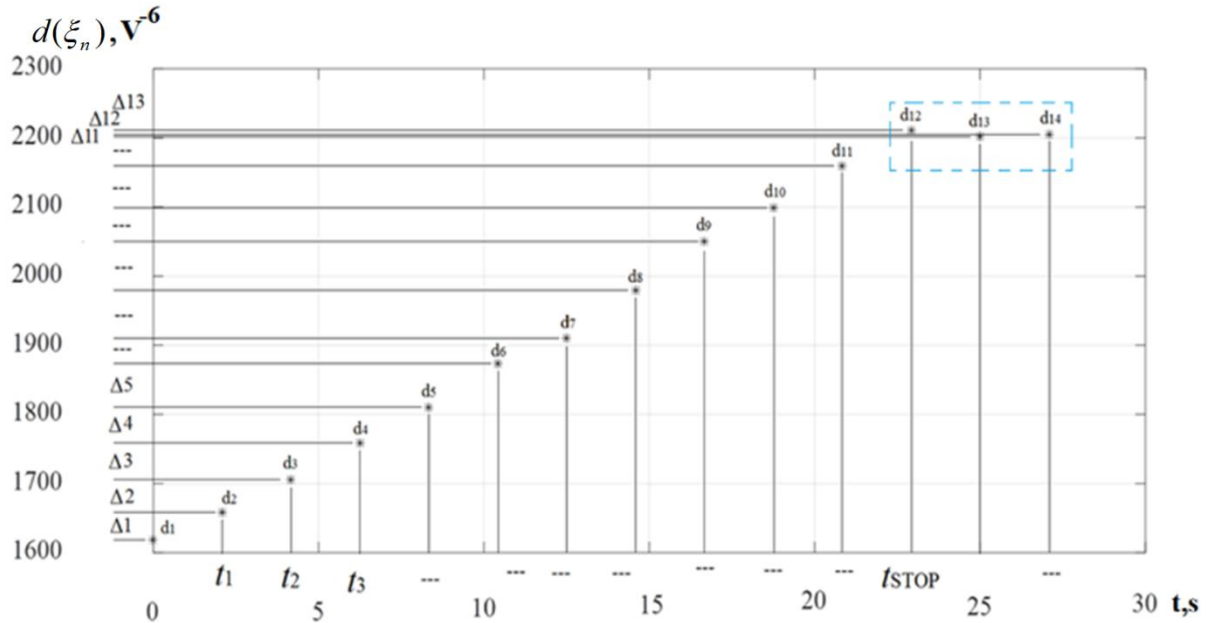

**Figure 9:** Estimation of the difference between the dispersion values of electrical probe-signal, calculated within the next and previous sliding window

However, values  $\Delta$  can differ from actual knowledge due to the influences of external subjective factors on the process of electrical probe-signals selection. These factors are as follows: changes in the angle of filling material irradiation during its polymerization due to dentist flaps, changes in backlight, etc. To eliminate these shortcomings, it is necessary to evaluate simultaneously the dynamics of tooth filling process on the basis of the results of simultaneous electrical probe-signal processing by methods determined by the mathematical model of such a signal in the form of periodically correlated random process.

## 5. Discussion

The obtained results of experimental recording and processing of electrical probe-signal implementations, which were recorded during irradiation of various common types of dental materials, showed that the proposed method of electrical probe-signal processing is workable, and a reasonable criterion is suitable for the determination the time of polymerization process termination. However, to confirm the adequacy of the mathematical model of the electrical probe-signal in the form of piecewise stationary random process and, accordingly, the method of processing, it is necessary to evaluate the reliability of the obtained results. Since the estimates of the dispersion of electrical probe-signal, calculated within the sliding window, are used to determine the time of polymerization process termination, it is convenient to use the Fisher's criterion. However, Fisher's criterion is based on additional assumptions about the independence and normality of data samples, and this requires a set of test statistics for both one type of dental material and for different types. And this is the purpose of further research.

## 6. Conclusion

Analysis of the method of non-destructive evaluation of the dynamics of tooth filling material polymerization process in dental practice is carried out. This method is based on the selection and

processing of electrical probe-signal, which is the result of reflection from the surface of composite irradiation with wavelength 380-500 nm with its subsequent transformation by means of the photocell into the signal of electrical nature - electrical probe-signal. In the structure of such signal there are signs of tooth filling material polymerization process and its termination. Accordingly, such signal is suitable for detecting the signs that would be indicators of the time of polymerization process termination.

The method of electrical probe-signal presentation in the form of piecewise stationary random process and evaluation of the statistics of the first order of electrical probe-signal within the sliding window broadcasts are first proposed.

As the criterion for determining the time of polymerization process termination we use the variation of dispersion estimates of electrical probe-signal, calculated within the sliding window which width is equal to the period of electrical probe-signal and which is transmitted in time on the trace of such signal.

It is determined that the values of variation of dispersion estimates of electrical probe-signal within the sliding window are sensitive to the changes in the state of dental process – tooth filling material polymerization the termination of this process, and can be used as the criterion for the determination of the time of polymerization process termination.

The application of the developed method of electrical probe-signal processing and the criterion for the determination of the time of polymerization process termination makes it possible to automate the function of time control of tooth filling material exposure, which can be implemented as a separate module of dental photopolymerizers to provide direct control of the exposure time of composite filling material and obtained tooth filling quality.

## 7. References

- [1] Bagramian R. A., Garcia-Godoy F., Volpe A. R. The global increase in dental caries. A pending public health crisis. *Am. J. Dent.* 2009. Vol. 22. P. 3–8.
- [2] Banoczy J., Rugg-Gunn A. Epidemiology and prevention of dental caries *Acta Med Acad.* 2013. Vol.42(2). P. 105–107.
- [3] Bönecker M. A., Andaló Tenuta L.M., Pucca Jr G. A., Bella Costa P., Pitts N. Social movement to reduce caries prevalence in the world. *Braz Oral Res São Paulo.* 2013. Vol. 27(1). P. 5–6.
- [4] Brown L. J., Wall T. P., Lazar V. Trends in total caries experience. Permanent and primary teeth. *J. Am. Dent. Assoc.* 2000. № 2. P. 223–231
- [5] Shinkaruk-Dykovytska M.M. Indicators of dental diseases and their dependence on phenotypic features of somatically healthy men from different regions of Ukraine: PhD thesis: 14.01.22 / Dentistry. Vinnytsia. 2016. p.450
- [6] Danilevsii M.V., Boysenko A.V., Politun A.M., Sidelnikova L.F. Therapeutic dentistry. O.O. Bogomolets National Medical University. Methods of patient examination, caries, pulpitis, periodontitis, dental foci caused by the disease. Kiev. "Health". 2004. Volume 2. p. 399p.
- [7] ISO 4049:2000(E). Dentistry – Polymer-based filling, restorative and luting materials.
- [8] ISO 4049:2009. Dentistry – Polymer-based restorative materials.
- [9] Nykytyuk V.V., Dediv L.E., Khvostivsii M.O. Method of computer evaluation of the strength of dental material by photoelectrical signal. *Bulletin of Sumy State University. Technical sciences.* 2012. № 2. pp. 182–188.
- [10] Marchenko N.B., Nechyporuk V.V., Nechyporuk O.P., Pepa Yu. V. Methods of estimating the accuracy of information-measuring diagnostic systems. Monograph. NAU, 2014. p. 377.
- [11] Dozorskyi, V., Nykytyuk, V., Dozorska, O., Dediv, L., Yavorska, E. The Method of Selection and Pre-processing of Electromyographic Signals for Bio-controlled Prosthetic of Hand. International Scientific and Technical Conference on Computer Sciences and Information Technologies, 2020, №1, pp. 188–191.
- [12] Bodnarchuk, I., Kunanets, N., Martsenko, S., Matsiuk, O., Matsiuk, A., Tkachuk, R., Shymchuk, H.: Information system for visual analyzer disease diagnostics. *CEUR Workshop Proceedings* 2488, pp. 43-56 (2019).